

PE5108

15A/10A 8-Outlet 1U Metered eco PDU



ATEN PE5108 eco PDUs are intelligent power distribution units equipped with 8 AC outlets and available in various IEC and NEMA socket configurations. Designed for enterprise-level data centers, they offer secure, centralized, and intelligent power management — including power on, off, and reboot capabilities — for IT equipment such as servers, storage systems, KVM switches, network devices, and serial-based hardware.

With the integration of optional environmental sensors*, they provide real-time monitoring of the data center's ambient conditions, enabling improved energy efficiency and proactive infrastructure management.

Eco PDUs provide remote power control and real-time power monitoring, enabling users to manage and track power status from virtually anywhere via a TCP/IP connection.

The eco PDU supports third-party SNMP v3 management software as well as ATEN's [eco DC](#) Energy Management Software. [eco DC](#) offers a user-friendly graphical interface for centralized management of multiple devices, allowing for easy configuration and real-time monitoring of connected equipment. When paired with sensor-enabled eco PDUs, [eco DC](#) also delivers detailed power analytics and reporting — organized by department or location — with accurate, real-time measurements of current, voltage, power, and energy consumption (watt-hour).

With advanced security features and user-friendly operation, the eco PDU offers the most convenient, reliable, and cost-effective solution for remotely managing power access across multiple computer installations, ensuring optimal allocation of power resources.

Note: Sensors are optional accessories. A sensor-enabled installation is required to generate comprehensive energy efficiency data and charts. A higher density of sensors will enhance the accuracy of the data.

Features

• Connections

- Support 10/100Mbit Ethernet Interface
- Support TCP/IP, UDP, HTTP, HTTPS, SSL, DHCP, SMTP, NTP, DNS, Auto Sense, Ping, Telnet, and SNMP V1,V2&V3
- Support 2-level account/password security, IP/MAC filter, 128 bit SSL, RADIUS
- Support : [eco DC](#), Browser (IE, Firefox, Chrome, Safari)

• Metering

- Bank level power metering and monitoring
- Environment Monitoring : support external temperature/temperature & humidity sensors for rack temperature and humidity monitoring
- Current, voltage, power, power dissipation, temperature, and humidity metering and threshold level setting

• Features available only on firmware-upgraded models with -ATB part number

- Supports SMPTS, IPv6, Modbus (Over TCP/IP), Auto Ping, TLS1.2, SSH
- Supports IEEE 802.1X
- Authentication: LDAP, TACACS+
- UI – heartbeat,schedule control, mail control, and setting rule

Specifications

Function	PE5108A	PE5108B	PE5108G
Electrical			
Nominal Input Voltage	100 – 120 VAC	100 – 240 VAC	100 – 240 VAC
Maximum Input Current	15A Max; 12A(UL de-rated)	15A Max; 12A(UL de-rated)	10A Max
Input Frequency	50-60 Hz	50-60 Hz	50-60 Hz
Input Connection	NEMA 5-15P	NEMA 6-15P	IEC 60320 C14
Input Power	1800 VA(Max); 1440 VA(UL de-rated)	3120 VA(Max); 2496 VA(UL de-rated)	2300 VA(Max)
Outlet Type	Total: 8 x NEMA 5-15R	Total: 8 x IEC320 C13	Total: 8 x IEC320 C13
Nominal Output Voltage	100 – 120 VAC	100 – 240 VAC	100 – 240 VAC
Maximum Output Current (Outlet)	NEMA 5-15R: 15A(Max); 12A(UL de-rated)	C13 : 15A(Max); 12A(UL de-rated)	C13 : 10A(Max)
Maximum Output Current (Bank)	15A(Max); 12A(UL de-rated)	15A(Max); 12A(UL de-rated)	10A(Max)
Maximum Output Current (Total)	15A(Max); 12A(UL de-rated)	15A(Max); 12A(UL de-rated)	10A(Max)
Breakers	1 x 15A Non-Fuse Breaker	1 x 15A Non-Fuse Breaker	1 x 15A Non-Fuse Breaker
Metering	Bank level Current, Voltage, VA , PF and KWh Monitoring	Bank level Current, Voltage, VA , PF and KWh Monitoring	Bank level Current, Voltage, VA , PF and KWh Monitoring
Outlet Switching	None	None	None
Environment Sensor Ports	2	2	2
Metering Accuracy	Voltage Range: 100VAC ~ 250VAC +/-1% Power Range: 100W ~ Maximum Capacity +/- 2% Current Range: 0.1A~1A +/- 0.1A, 1A~20A +/- 1%	Voltage Range: 100VAC ~ 250VAC +/-1% Power Range: 100W ~ Maximum Capacity +/- 2% Current Range: 0.1A~1A +/- 0.1A, 1A~20A +/- 1%	Voltage Range: 100VAC ~ 250VAC +/-1% Power Range: 100W ~ Maximum Capacity +/- 2% Current Range: 0.1A~1A +/- 0.1A, 1A~20A +/- 1%
Physical Properties			
Dimensions (L x W x H)	43.24 x 4.40 x 21.93 cm	43.24 x 4.40 x 21.93 cm	43.24 x 4.40 x 21.93 cm
Weight	2.77 kg	2.82 kg	2.82 kg
Power Cord Length	3 m	3 m	3 m
Environmental			
Temperature (Operating / Storage)	0 – 50°C / -20 – 60°C	0 – 50°C / -20 – 60°C	0 – 50°C / -20 – 60°C
Humidity (Operating & Storage)	0 – 80% RH, Non-Condensing	0 – 80% RH, Non-Condensing	0 – 80% RH, Non-Condensing
Compliance			
EMC Verification	FCC, Others by Request	FCC, Others by Request	CE, Others by Request
Safety Verification	UL, Others by Request	UL, Others by Request	CE-LVD, Others by Request
Note	For some of rack mount products, please note that the standard physical dimensions of WxDxH are expressed using a LxWxH format.		

Diagram

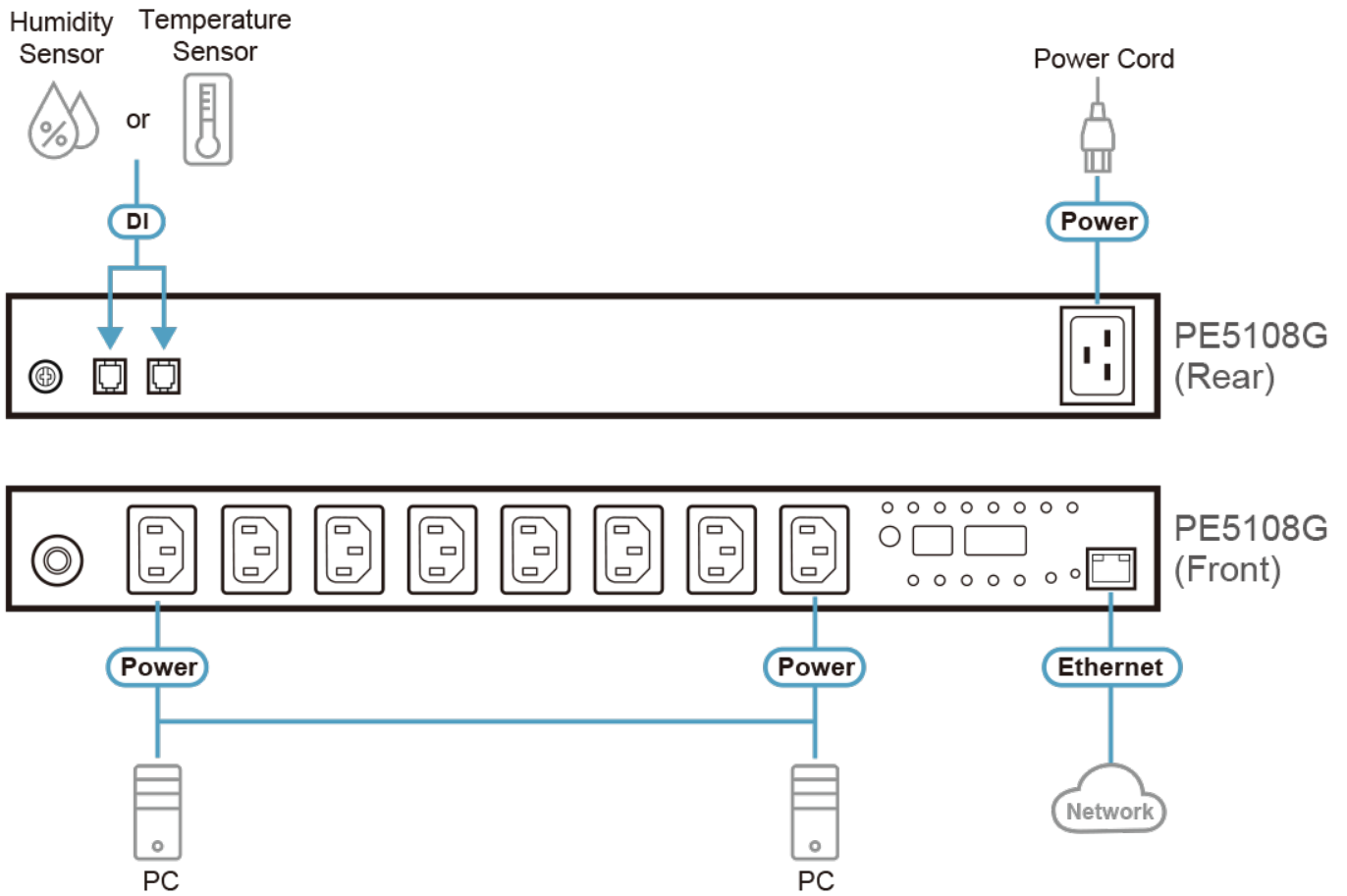

ATEN International Co., Ltd.

3F., No.125, Sec. 2, Datong Rd., Sijhih District., New Taipei City 221, Taiwan
Phone: 886-2-8692-6789 Fax: 886-2-8692-6767
www.aten.com E-mail: marketing@aten.com



© Copyright 2015 ATEN® International Co., Ltd.
ATEN and the ATEN logo are trademarks of ATEN International Co., Ltd.
All rights reserved. All other trademarks are the property of their respective owners.